

**Particular Features:**

Specially designed internal spring provides 1,5 mm torsion  
Cam does not rotate beyond quarter turn due to lid stop  
IP65 is optional

**Application:**

Electric panels, machinery covers

**Selection Instructions:**

1. Select housing from page 2 for the standard version or page 3 for the safety version
2. Select drive or knob from page 4 for the standard version or page 5 for the safety version
3. Select cam from page 6 or 7
4. Select IP65 if requested by adding "-I" to the series-no.

**Part Number Example**

L10A(I) - ED - 03ED - 33AG

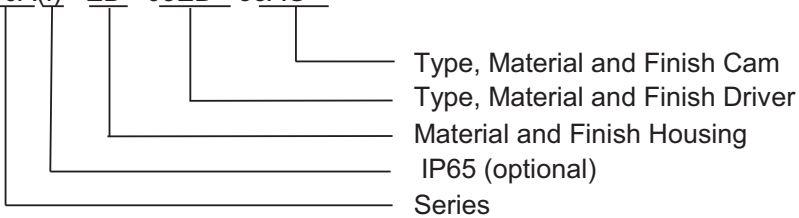

## Housing

Version	Materials / Finish	Part-No.
	Zamak® DIN-EN1774-ZnAl4Cu1 chrome plated (CrVI-free)	L10A-ED-*
	Zamak® DIN-EN1774-ZnAl4Cu1 chrome plated (CrVI-free) IP65	L10AI-ED-*
	Zamak® DIN-EN1774-ZnAl4Cu1 black coated (CrVI-free)	L10A-EH-*
	Zamak® DIN-EN1774-ZnAl4Cu1 black coated (CrVI-free) IP65	L10AI-EH-*
	Polyamid Black PA6 GFR30	L10A-K-*
	Polyamid Black PA6 GFR30 IP65	L10AI-K-*



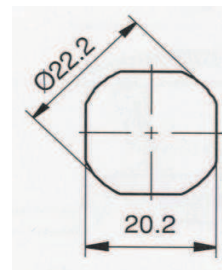
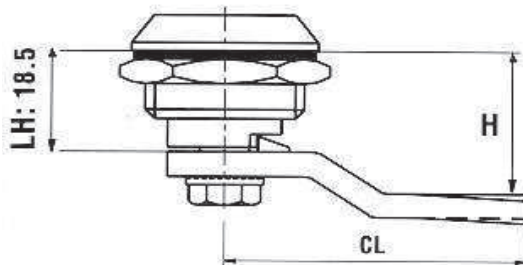















## Dimensions and Hole Preparation



CL and H according to the cam, see page 6 and 7

\* Order examples for complete part numbers see page 8

## Drivers

<b>3mm Double Bit</b> 		<b>5mm Double Bit</b> 		<b>Slot 2X4</b> 		<b>Slot</b> 	
<b>Material / Finish</b>	<b>Part-No.</b>	<b>Material / Finish</b>	<b>Part-No.</b>	<b>Material / Finish</b>	<b>Part-No.</b>	<b>Material / Finish</b>	<b>Part-No.</b>
Zamak® Chrome	01ED	Zamak® Chrome	02ED	Zamak® Chrome	03ED	Zamak® Chrome	04ED
Zamak® Black	01EH	Zamak® Black	02EH	Zamak® Black	03EH	Zamak® Black	04EH
Polyamid Black	01K	Polyamid Black	02K	Polyamid Black	03K		
<b>6mm Square</b> 		<b>7mm Square</b> 		<b>8mm Square</b> 		<b>Railway</b> 	
<b>Material / Finish</b>	<b>Part-No.</b>	<b>Material / Finish</b>	<b>Part-No.</b>	<b>Material / Finish</b>	<b>Part-No.</b>	<b>Material / Finish</b>	<b>Part-No.</b>
Zamak® Chrome	05ED	Zamak® Chrome	06ED	Zamak® Chrome	07ED	Zamak® Chrome	08ED
Zamak® Black	05EH	Zamak® Black	06EH	Zamak® Black	07EH	Zamak® Black	08EH
Polyamid Black	05K	Polyamid Black	06K	Polyamid Black	07K		
<b>8mm Square Slot</b> 		<b>7mm Triangular</b> 		<b>8mm Triangular</b> 		<b>9mm Triangular</b> 	
<b>Material / Finish</b>	<b>Part-No.</b>	<b>Material / Finish</b>	<b>Part-No.</b>	<b>Material / Finish</b>	<b>Part-No.</b>	<b>Material / Finish</b>	<b>Part-No.</b>
Zamak® Chrome	09ED	Zamak® Chrome	10ED	Zamak® Chrome	11ED	Zamak® Chrome	12ED
Zamak® Black	09EH	Zamak® Black	10EH	Zamak® Black	11EH	Zamak® Black	12EH
		Polyamid Black	10K	Polyamid Black	11K	Polyamid Black	12K
<b>8mm Inner Hexagon</b> 		<b>10mm Inner Hexagon</b> 		<b>6mm Inner Square</b> 		<b>Torx T30</b> 	
<b>Material / Finish</b>	<b>Part-No.</b>	<b>Material / Finish</b>	<b>Part-No.</b>	<b>Material / Finish</b>	<b>Part-No.</b>	<b>Material / Finish</b>	<b>Part-No.</b>
Zamak® Chrome	13ED	Zamak® Chrome	14ED	Zamak® Chrome	15ED	Zamak® Chrome	16ED
Zamak® Black	13EH	Zamak® Black	14EH	Zamak® Black	15EH	Zamak® Black	16EH
<b>Knob Type X</b> 		<b>Knob Type Y</b> 					
<b>Material / Finish</b>	<b>Part-No.</b>	<b>Material / Finish</b>	<b>Part-No.</b>				
Zamak® Chrome	18ED	Zamak® Chrome	19ED				
Zamak® Black	18EH	Zamak® Black	19EH				
Polyamid Black	18K	Polyamid Black	19K				

## Keys

<p><b>3mm Double Bit</b></p> 	<p><b>5mm Double Bit</b></p> 		
<p><b>Material / Finish Part-No.</b></p>	<p><b>Material / Finish Part-No.</b></p>		
<p>Zamak® Chrome Cam-K-01ED</p>	<p>Zamak® Chrome Cam-K-02ED</p>		
<p><b>6mm Square</b></p> 	<p><b>7mm Square</b></p> 	<p><b>8mm Square</b></p> 	
<p><b>Material / Finish Part-No.</b></p>	<p><b>Material / Finish Part-No.</b></p>	<p><b>Material / Finish Part-No.</b></p>	
<p>Zamak® Chrome Cam-K-05ED</p>	<p>Zamak® Chrome Cam-K-06ED</p>	<p>Zamak® Chrome Cam-K-07ED</p>	
<p><b>7mm Triangular</b></p> 	<p><b>8mm Triangular</b></p> 	<p><b>9mm Triangular</b></p> 	
<p><b>Material / Finish Part-No.</b></p>	<p><b>Material / Finish Part-No.</b></p>	<p><b>Material / Finish Part-No.</b></p>	
<p>Zamak® Chrome K10ED</p>	<p>Zamak® Chrome K11ED</p>	<p>Zamak® Chrome K12ED</p>	

## Drivers

Version	Material/Finish	Part-No.
 <p><b>SAFETY QUARTER TURN</b></p>	Zamak® DIN-EN1774-ZnAl4Cu1 chrome plated (CrVI-free)	L10BI-ED-30ED-*
	Zamak® DIN-EN1774-ZnAl4Cu1 black coated (CrVI-free)	L10BI-ED-30EH-*
	Zamak® DIN-EN1774-ZnAl4Cu1 chrome plated (CrVI-free)	L10B-KEY-ED
	Zamak® DIN-EN1774-ZnAl4Cu1 black coated (CrVI-free)	L10B-KEY-EH

## Dimensions and Hole Preparation

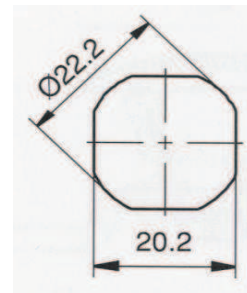
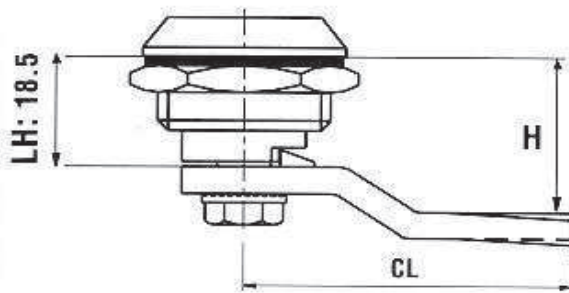

CL and H according to the cam, see page 6 and 7

\* Order examples for complete part numbers see page 8

## Cams with Stopper

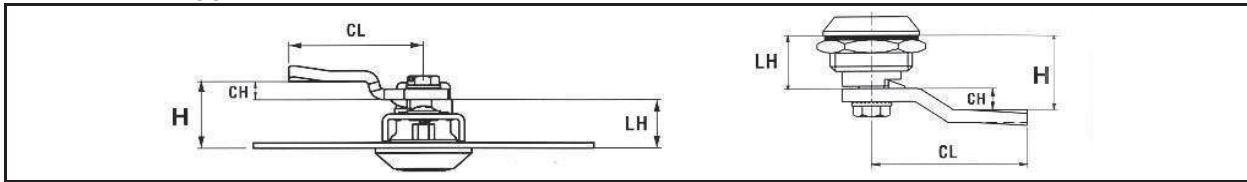

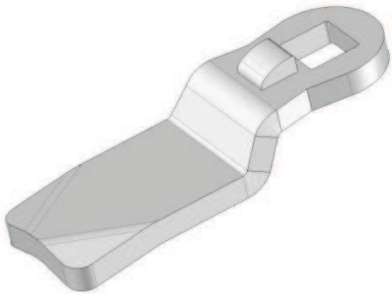
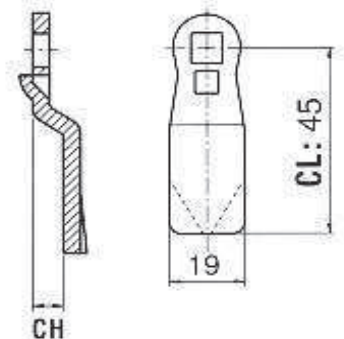
	H	CH	CL	Materials / Finish	Part-No.
<b>Version A</b>    	4,5	-14	45	Steel / Zinc plated	01AG
	6,5	-12	45	Steel / Zinc plated	02AG
	8,5	-10	45	Steel / Zinc plated	03AG
	10,5	-8	45	Steel / Zinc plated	04AG
	12,5	-6	45	Steel / Zinc plated	05AG
	14,5	-4	45	Steel / Zinc plated	06AG
	16,5	-2	45	Steel / Zinc plated	07AG
	18,5	0	45	Steel / Zinc plated	08AG
				Stainless Steel	08BP
	20,5	2	45	Stainless Steel	09BP
	21,5	3	45	Steel / Zinc plated	10AG
				Stainless Steel	10BP
	22,5	4	45	Steel / Zinc plated	11AG
				Stainless Steel	11BP
	24,5	6	45	Steel / Zinc plated	12AG
					12BP
	26,5	8	45	Steel / Zinc plated	13AG
				Stainless Steel	13BP
	28,5	10	45	Steel / Zinc plated	14AG
				Stainless Steel	14BP
	30,5	12	45	Steel / Zinc plated	15AG
			Stainless Steel	15BP	
32,5	14	45	Steel / Zinc plated	16AG	
34,5	16	45	Steel / Zinc plated	17AG	
36,5	18	45	Steel / Zinc plated	18AG	
			Stainless Steel	18BP	
38,5	20	45	Steel / Zinc plated	19AG	
40,5	22	45	Steel / Zinc plated	20AG	
42,5	24	45	Steel / Zinc plated	21AG	

## Cams with Stopper

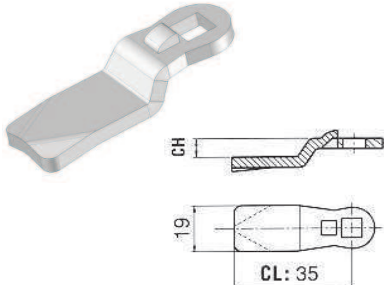
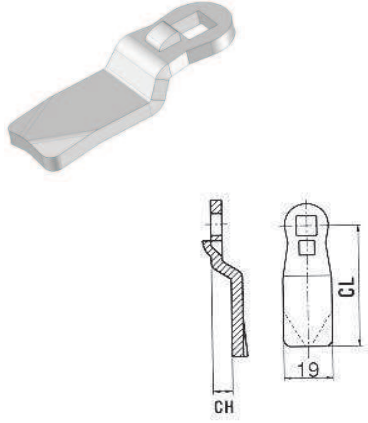
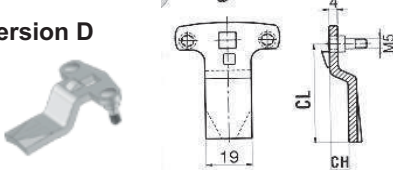
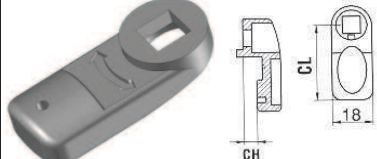
	H	CH	CL	Materials / Finish	Part-No.
<b>Version B</b> 	16,5	-2	35	Steel / Zinc plated	22AG
	18,5	0	35	Steel / Zinc plated	23AG
	20,5	2	35	Steel / Zinc plated	24AG
	22,5	4	35	Steel / Zinc plated	25AG
	24,5	6	35	Steel / Zinc plated	26AG
	25,5	7	35	Steel / Zinc plated	27AG
	28,5	10	35	Steel / Zinc plated	28AG
	44,5	26	35	Steel / Zinc plated	29AG
<b>Version C</b> 	18,5	0	29	Steel / Zinc plated	30AG
	18,5	0	38	Steel / Zinc plated	31AG
	18,5	0	66	Steel / Zinc plated	32AG
				Stainless Steel	32BP
	18,5	0	51	Steel / Zinc plated	33AG
	21,5	3	38	Steel / Zinc plated	34AG
	21,5	3	51	Steel / Zinc plated	35AG
	24,5	6	37	Steel / Zinc plated	36AG
	25,5	7	44	Steel / Zinc plated	37AG
	25,5	7	49	Steel / Zinc plated	38AG
				Stainless Steel	38BP
	28,5	10	48	Steel / Zinc plated	39AG
47,5	29	45	Steel / Zinc plated	40AG	
<b>Version D</b> 	18,5	0	51	Steel / Zinc plated	50AG
	25,5	7	49	Steel / Zinc plated	51AG
	30,5	12	46	Steel / Zinc plated	52AG
<b>Version E</b> 	14,5	-4	45	Polyamid Black	60K
	18,5	0	25	Polyamid Black	61K
	18,5	0	35	Polyamid Black	62K
	22,5	4	45	Polyamid Black	63K
	24,5	6	35	Polyamid Black	64K

## Order example

Spring, Nut and Screw are always part of the set, please order like the following examples



Housing in plastic, selected from page 2

L10A-K-

Drive 8mm square, Zamak® chrome,  
selected from page 4

07ED-

Cam Version A, steel zinc plated, CH = 14mm  
selected from page 6

16AG

### Complete part number

**L10A-K-07ED-16AG**



Housing in Zamak®, chrom plated, IP65,  
selected from page 3

L10AI-ED-

Drive Knob Type X, zamac black,  
selected from page 4

18EH-

Cam Version A, steel zinc plated, CH = 8mm  
selected from page 6

13AG

### Complete part number

**L10AI-ED-18EH-13AG**

All locks will be delivered as pre-assembled parts