

**Particular Features:**

Spring loaded cam provides depress-to-lock action

Distance between inside of lock face and front of cam is fixed at 22,5 mm

**Application:**

Machinery covers, electric panels



**Selection Instructions:**

1. Select drive from page 26
2. Select lefthand or right hand drive

**Part Number Example**

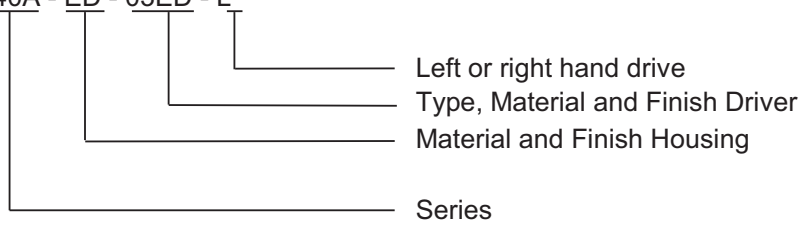
L40A - ED - 03ED - L



Version	Materials / Finish	Part-No.
	Zamak® DIN-EN1774-ZnAl4Cu1 chrome plated (CrVI-free) left hand drive	L40A-ED-*-L
	Zamak® DIN-EN1774-ZnAl4Cu1 chrome plated (CrVI-free) right hand drive	L40A-ED-*-R



push to door



cam will move upright  
when touches the body

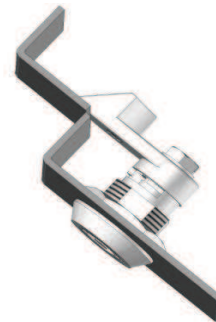





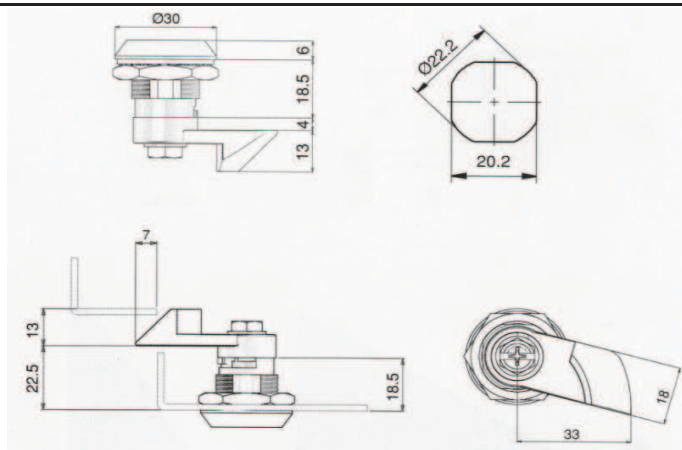







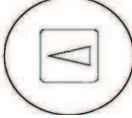
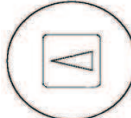

When the cam is free, cam will move  
downright by spring and the door  
will be locked

### Dimensions and Hole Preparation



\* drive selected from page 26

## Drivers

<b>3mm Double Bit</b> 	<b>5mm Double Bit</b> 	<b>Slot 2X4</b> 	<b>Slot</b> 
<b>Material / Finish</b> <b>Part-No.</b> Zamak® Chrome   01ED Zamak® Black   01EH Polyamid Black   02K	<b>Material / Finish</b> <b>Part-No.</b> Zamak® Chrome   02ED Zamak® Black   02EH Polyamid Black   02K	<b>Material / Finish</b> <b>Part-No.</b> Zamak® Chrome   03ED Zamak® Black   03EH Polyamid Black   03K	<b>Material / Finish</b> <b>Part-No.</b> Zamak® Chrome   04ED Zamak® Black   04EH
<b>6mm Square</b> 	<b>7mm Square</b> 	<b>8mm Square</b> 	<b>Railway</b> 
<b>Material / Finish</b> <b>Part-No.</b> Zamak® Chrome   05ED Zamak® Black   05EH Polyamid Black   05K	<b>Material / Finish</b> <b>Part-No.</b> Zamak® Chrome   06ED Zamak® Black   06EH Polyamid Black   06K	<b>Material / Finish</b> <b>Part-No.</b> Zamak® Chrome   07ED Zamak® Black   07EH Polyamid Black   07K	<b>Material / Finish</b> <b>Part-No.</b> Zamak® Chrome   08ED Zamak® Black   08EH
<b>8mm Square Slot</b> 	<b>7mm Triangular</b> 	<b>8mm Triangular</b> 	<b>9mm Triangular</b> 
<b>Material / Finish</b> <b>Part-No.</b> Zamak® Chrome   09ED Zamak® Black   09EH	<b>Material / Finish</b> <b>Part-No.</b> Zamak® Chrome   10ED Zamak® Black   10EH Polyamid Black   10K	<b>Material / Finish</b> <b>Part-No.</b> Zamak® Chrome   11ED Zamak® Black   11EH Polyamid Black   11K	<b>Material / Finish</b> <b>Part-No.</b> Zamak® Chrome   12ED Zamak® Black   12EH Polyamid Black   12K
<b>8mm Inner Hexagon</b> 	<b>10mm Inner Hexagon</b> 	<b>6mm Inner Square</b> 	<b>Torx T30</b> 
<b>Material / Finish</b> <b>Part-No.</b> Zamak® Chrome   13ED Zamak® Black   13EH	<b>Material / Finish</b> <b>Part-No.</b> Zamak® Chrome   14ED Zamak® Black   14EH	<b>Material / Finish</b> <b>Part-No.</b> Zamak® Chrome   15ED Zamak® Black   15EH	<b>Material / Finish</b> <b>Part-No.</b> Zamak® Chrome   16ED Zamak® Black   16EH