

Particular Features:

- Used for the cabinets that require better sealing under vibration conditions
- Lock has 6 mm compression ratio
- Lock also provides noise isolation
- Different driver alternatives are available
- Standard cams without stopper are applied to these locks

Application:

Electric panels, machinery covers, railway applications, construction equipment

Selection Instructions:

1. Select drive and cam from page 47

Part Number Example



Version	Materials / Finish	Part-No.
	Zamak® DIN-EN1774-ZnAl4Cu1 chrome plated (CrVI-free)	CL10-ED-*
	Zamak® DIN-EN1774-ZnAl4Cu1 black coated (CrVI-free)	CL10-EH-*

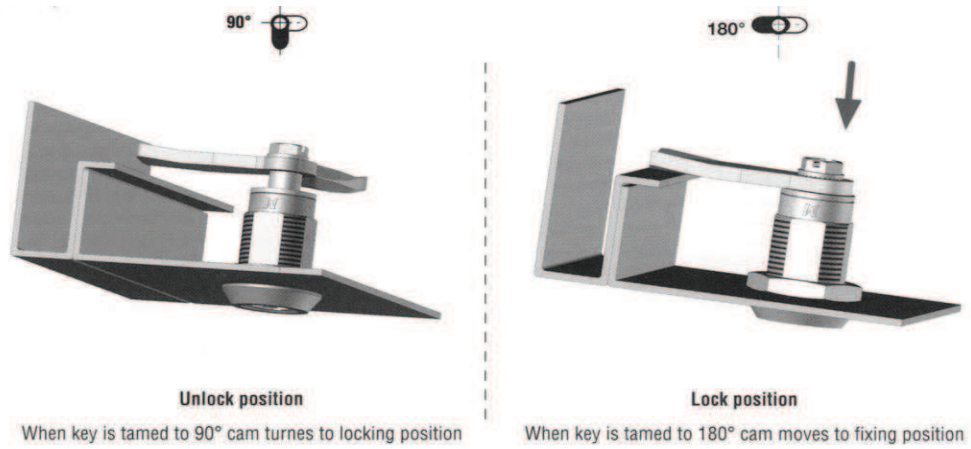



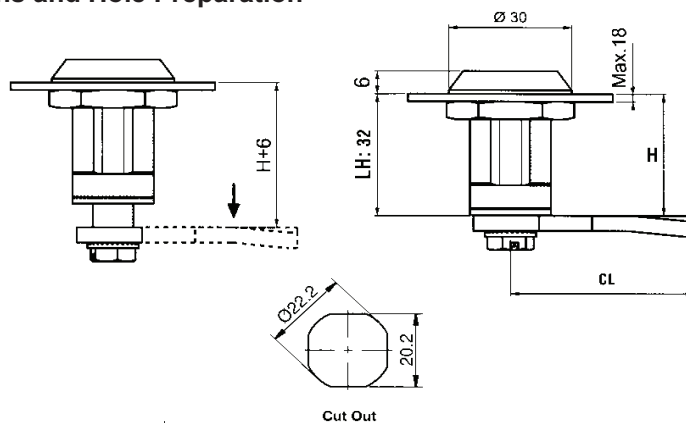







Dimensions and Hole Preparation



* drive selected from page 47

Drivers

3mm Double Bit 	5mm Double Bit 	Slot 2X4 	8mm Square 
Material / Finish Part-No. Zamak® Chrome 01ED Zamak® Black 01EH	Material / Finish Part-No. Zamak® Chrome 02ED Zamak® Black 02EH	Material / Finish Part-No. Zamak® Chrome 03ED Zamak® Black 03EH	Material / Finish Part-No. Zamak® Chrome 07ED Zamak® Black 07EH
Railway 	7mm Triangular 	8mm Triangular 	8mm Inner Hexagon 
Material / Finish Part-No. Zamak® Chrome 08ED Zamak® Black 08EH	Material / Finish Part-No. Zamak® Chrome 10ED Zamak® Black 10EH	Material / Finish Part-No. Zamak® Chrome 11ED Zamak® Black 11EH	Material / Finish Part-No. Zamak® Chrome 13ED Zamak® Black 13EH
8mm Hexagon with security pin 	Tubular Key 		
Material / Finish Part-No. Zamak® Chrome 18ED Zamak® Black 18EH	Material / Finish Part-No. Zamak® Chrome 19ED Zamak® Black 19EH		

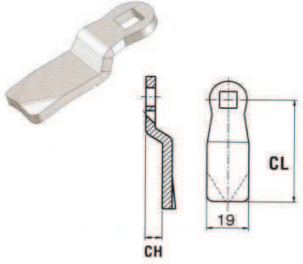
Cams	H	CH	CL	Materials / Finish	Part-No.
	32	0	29	Steel / Zinc plated	130AG
	32	0	38	Steel / Zinc plated	131AG
	32	0	45	Steel / Zinc plated	108AG
	32	0	51	Steel / Zinc plated	133AG
	32	0	66	Steel / Zinc plated	132AG
	35	3	38	Steel / Zinc plated	134AG
	35	3	45	Steel / Zinc plated	110AG
	35	3	51	Steel / Zinc plated	135AG
	38	6	37	Steel / Zinc plated	136AG
	38	6	45	Steel / Zinc plated	112AG
	39	7	44	Steel / Zinc plated	137AG
	39	7	49	Steel / Zinc plated	138AG
	42	10	48	Steel / Zinc plated	139AG
	44	12	45	Steel / Zinc plated	115 AG