

Version	Materials / Finish	Part-No.
	Polyamid black Version T1 for hexavalent screws	D10-T1
	Polyamid black Version T1 for counter sunk screws	D10-T2

Hole Preparation / Dimensions

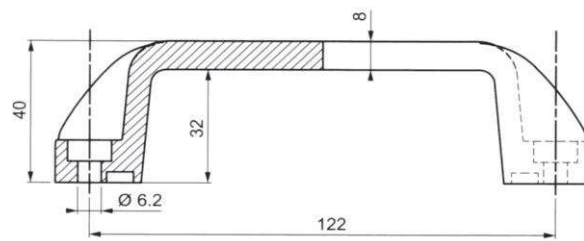

T1 for hexavalent screws

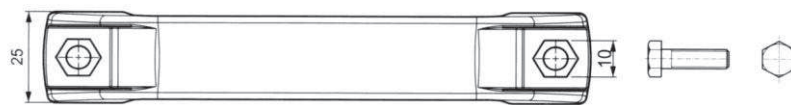

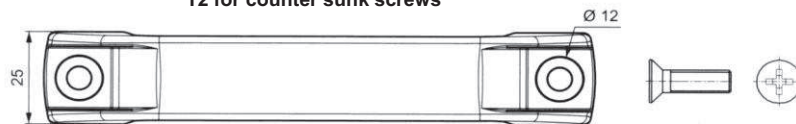

T2 for counter sunk screws

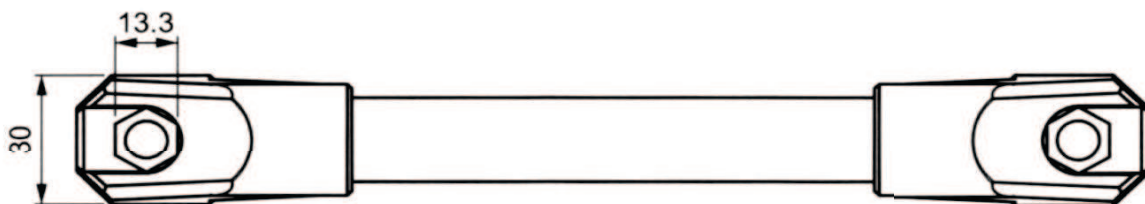
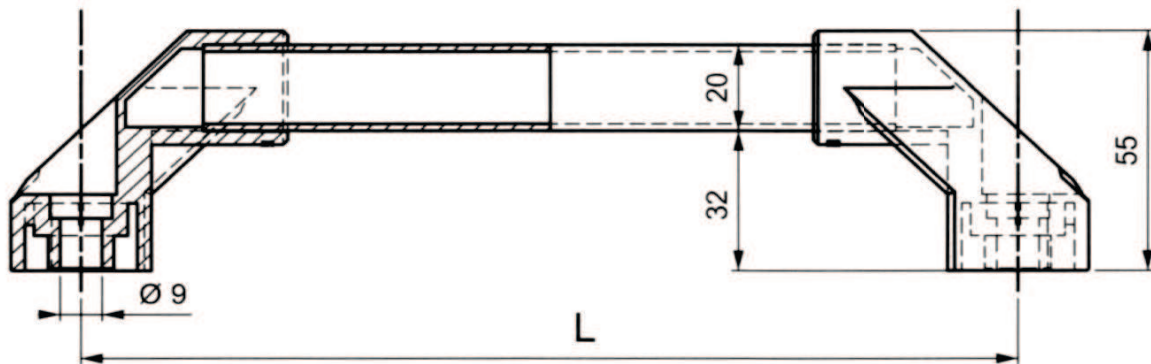

Version	Materials / Finish	Part-No.
	Handle aluminium / fixing part Polyamid length 100 mm	D20-L100
	Handle aluminium / fixing part Polyamid length 200 mm	D20-L200
	Handle aluminium / fixing part Polyamid length 300 mm	D20-L300
	Handle aluminium / fixing part Polyamid length 400 mm	D20-L400

Hole Preparation / Dimensions



Version	Materials / Finish	Part-No.
	Polyamid black	
	length 300 mm	D30-300
	length 400 mm	D30-400
	length 500 mm	D30-500
	length 600 mm	D30-600
	length 700 mm	D30-700
	length 800 mm	D30-800
	length 1.000 mm	D30-1000

Hole Preparation / Dimensions

